

TF8MHR-064-130I

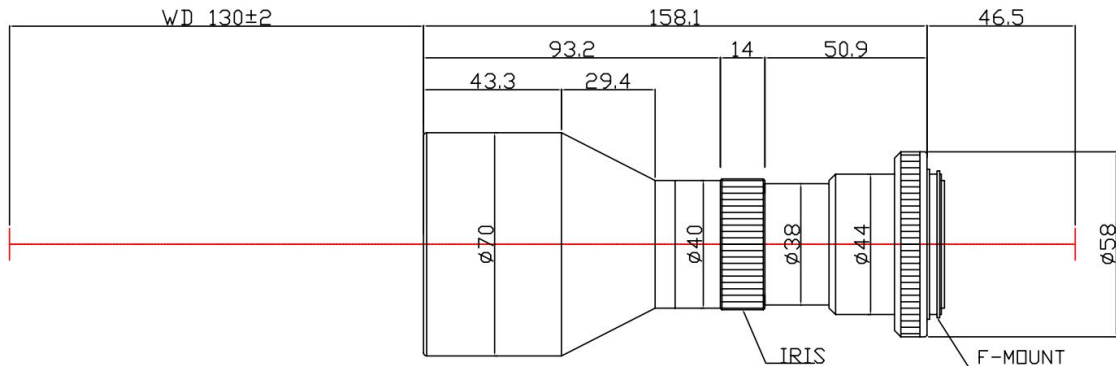

The Object Side Telecentric Lens TF8MHR-064-130I is suitable for sensors up to 8 megapixel and with an image format of 8M (23mm).

Technical Data

Magnification	0.64 X
Mount Type	F-Mount
Aperture (F)	5.56
Working Distance (WD)	130
Depth of Field (DOF)	597 µm
Resolution (Object Side)	5.8 µm
Numerical Aperture (NA)	0.0576
Image Format (max.)	8M (23mm)
Megapixel	8 MP
Field of View (FOV)	28.28mm X 21.31mm @ 8M CCD
Telecentric Type	Object Side
Telecentricity	0.02 °
Optical Distortion (max.)	0.06 %
Special Feature	Super High Res

