

TC5M-40-65IC

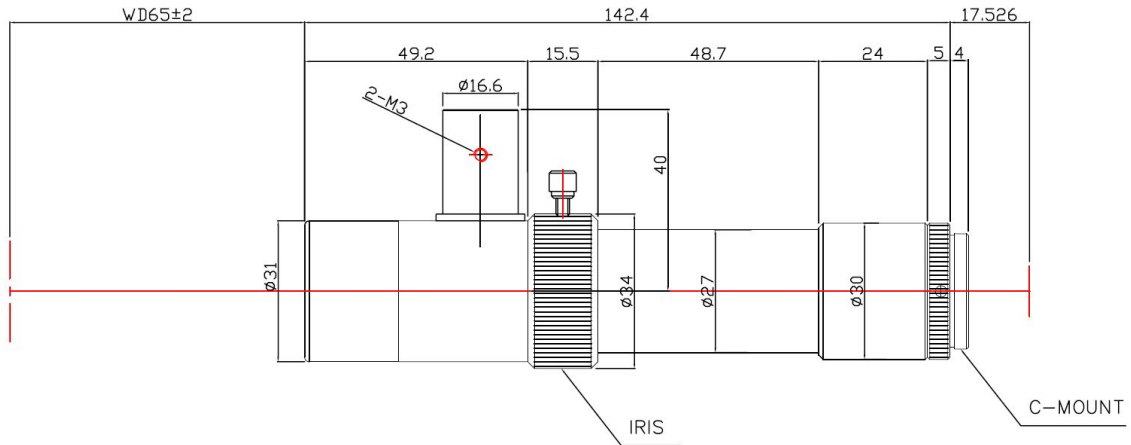

The Object Side Telecentric Lens TC5M-40-65IC is suitable for sensors up to 5 megapixel and with an image format of 2/3 inch.

Technical Data

Magnification	4 X
Mount Type	C-Mount
Aperture (F)	12.5
Working Distance (WD)	65
Depth of Field (DOF)	31.3 μ m
Resolution (Object Side)	2.09 μ m
Numerical Aperture (NA)	0.6
Image Format (max.)	2/3 inch
Megapixel	5 MP
Field of View (FOV)	2.1mm x 1.8mm @5M CCD
Telecentric Type	Object Side
Telecentricity	0.02 °
Optical Distortion (max.)	0.03 %
Special Feature	Super High Res

