

CMFA2020ND

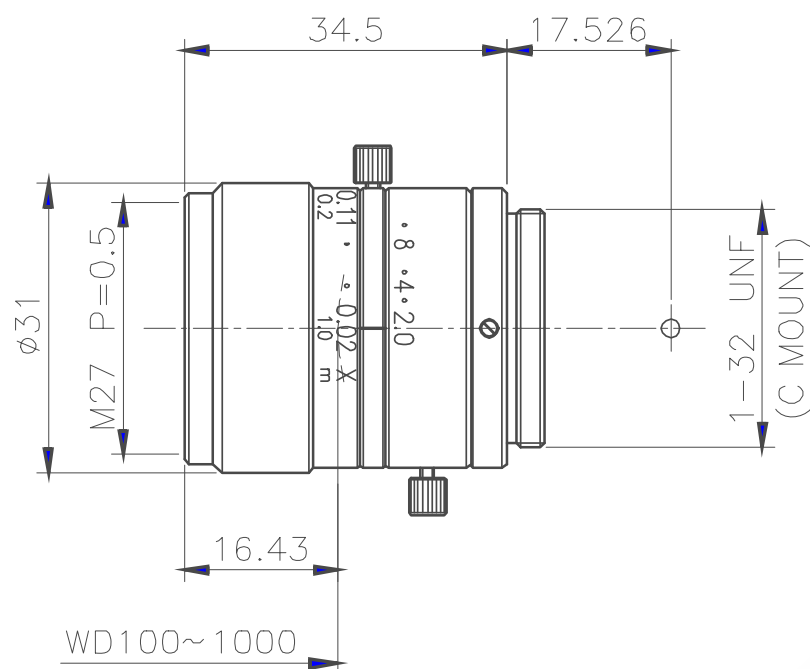

The C-Mount lens Lensagon CMFA2020ND is suitable for common sensors up to 1 megapixel with an image format of 2/3 inch. It is characterized by a particularly high light intensity.

Technical Data

Mount	C-Mount
Sensor	2/3 inch
Focal Length	20 mm
Aperture	2
MOD	0.1 m
Megapixel	1-2 MP
Filter	M27 P=0.5
IR Cut	No
Distortion	-0.1 %
Weight	55 g
Iris	manual-lock
Focus	manual-lock



Light Sensitive



Megapixel