

Lensagon CY3519

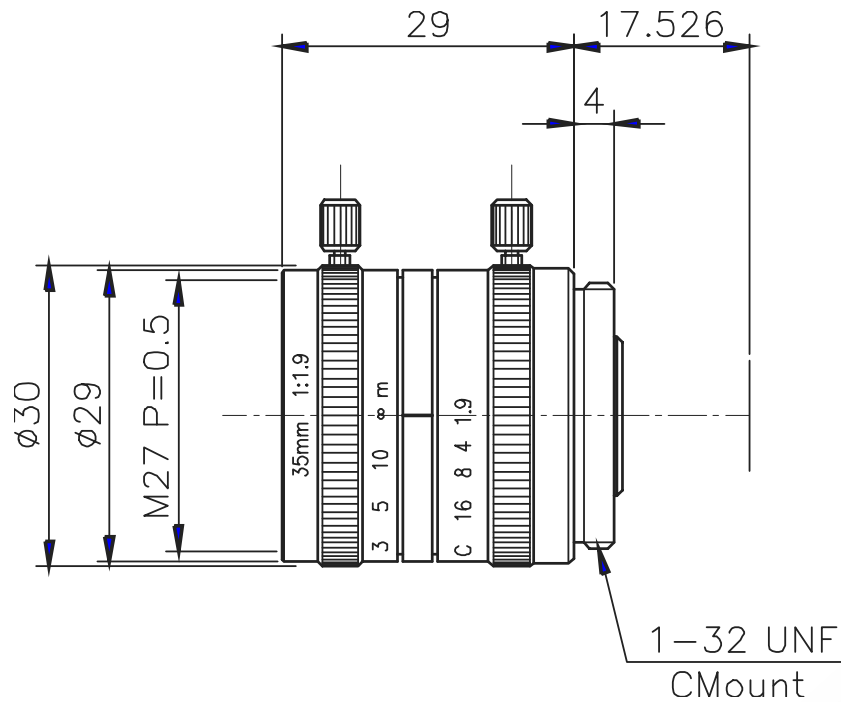

The C-Mount lens Lensagon CY3519 is suitable for sensors below 1 megapixel with an image format of 2/3 inch. It is characterized by a particularly high light intensity.

Technical Data

Mount	C-Mount
Sensor	2/3 inch
Focal Length	35 mm
Aperture	1.9
MOD	0.5 m
Back Focal	12.37 mm
Megapixel	0.4 MP
Filter	M27 P=0.5
IR Cut	No
Weight	49 g
Iris	manual-lock
Focus	manual-lock
Typ	Standard

